

ACB | *Vento!*

Ventiladores

Fans / Ventilateurs / Ventilatoren / Ventilatori

3

Cómo elegir tu ventilador

How to choose your fan / Comment choisir votre ventilateur / Auswahl des geeigneten ventilators / Come scegliere il suo ventilatore

Tamaño

Size / Dimension / Grösse / Dimensioni

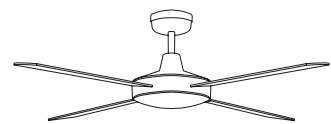

∅ <107CM

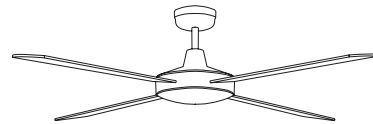

∅ 107-132CM

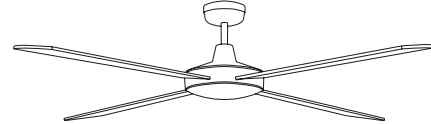

∅ >132CM

Luz

Light / Lumière / Licht / Luce

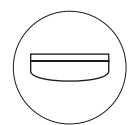

Sin luz
Without light
Sans lumière
Ohne Licht
Senza luce

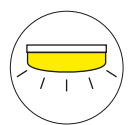

Con luz LED
With LED light
Avec lumière LED
Mit LED-licht
Con luce LED

Motor

Motor / Moteur / Motor / Motore



Corriente alterna con 3 velocidades
Alternating current with 3 speeds
Courant alterne avec 3 vitesses
Wechselstrom mit 3 Geschwindigkeiten
Corrente alterna con 3 velocità



Corriente continua con 6 velocidades
Direct current with 6 speeds
Courant continu avec 6 vitesses
Gleichstrom mit 6 Geschwindigkeiten
Corrente continua con 6 velocità

Función verano - invierno

Function summer - winter / Fonction été - hiver / Funktion Sommer - Winter / Funzione estate - inverno

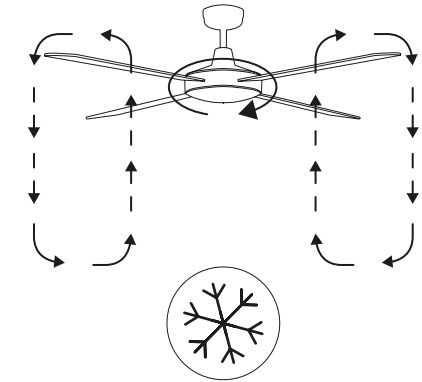
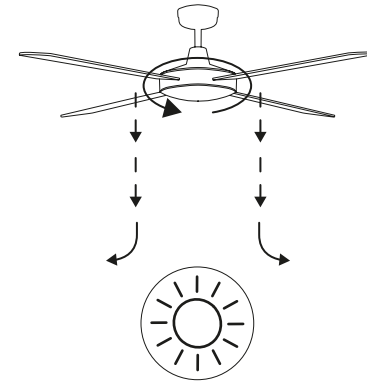

Aspas

Blades / Pales / Schaufeln / Pale

La cantidad de aire depende de la inclinación de las aspas, no del número de ellas

The air flow depends on the inclination of the blades, not on the number of them / Le débit d'air dépend de l'inclinaison des pales et non du nombre d'entre elles / Der Luftstrom hängt von der Neigung der Schaufeln ab, nicht von deren Anzahl / Il flusso dell'aira dipende della inclinazione delle pale, non dalla quantità.

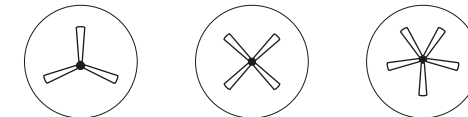

Material

Material / Matériel / Material / Materiale



ABS es un tipo de plástico muy resistente y aerodinámico
ABS is a kind of plastic, very resistant and aerodynamic / ABS est un type de plastique très résistant et aérodynamique / ABS ist eine Art Kunststoff, sehr widerstandsfähig und aerodynamisch / ABS è una specie di plastica, molto resistente e aerodinamica.



PC es un tipo de plástico muy resistente y transparente
PC is a kind of plastic, very resistant and transparent / PC est un type de plastique très résistant et transparent / PC ist eine Art Kunststoff, sehr widerstandsfähig und transparent / PC è una specie di plastica, molto resistente e trasparente



Contrachapado es un derivado de la madera con mucha resistencia
Plywood is a very resistant material derived from wood / Contre-plaqué est un dérivé du bois très résistant / Sperrholz ist ein sehr widerstandsfähiges Material, das aus Holz erzeugt wird / Compensato è un materiale molto resistente derivato dal legno.



Las aspas de madera son mas silenciosas
Wooden Blades are quieter / Les pales en bois sont plus silencieuses / Hölzerne Schaufeln sind leiser / Le pale di legno sono più silenziose.

Índice Ventiladores

Index / Indice / Index / Indice



Nombre	Dibujo	Color	Motor				Peso	Tamaño		IP	Airflow	Aspas			Luz				Mando		Código	Página	
			Tipo	Potencia	Velocidades	Función		Kg	Diámetro			Habitación	Grado IP	Número y forma	Material	Reversibles	Si/No	Dimable	Lumens	Kelvin			Potencia
Arashi		BCO	DC MOTOR	40W MOTOR	6	—	3.8	58 cm	S 75m²	—	48 m³/min 1695 CFM		ABS			3 Steps	1900 lm	3000K 4000K 6000K	LED 18W			V2515593B	6-7
Blaast		BCO	AC MOTOR	30W MOTOR	3		5.35	50 cm	S 75m²	—	42 m³/min 1483 CFM		PC			—	1440 lm	3000K 4500K 6000K	LED 24W			V2512503B	8-9
Levante		OPAL FUMÉ	AC MOTOR	10W MOTOR	3		3.5	40 cm	S 75m²	—	33 m³/min 1165 CFM		PC			3 Steps	1920 lm	3000K 4000K 6000K	LED 24W		—	V2511403FU	10-11
Zonda		BCO	AC MOTOR	61W MOTOR	3		8.3	48 cm 107 cm	M 73-18m²	—	102 m³/min 3600 CFM		ABS			—	4000lm	3000K 4000K 6000K	LED 47W			V2514423B	12-13
Barine		BCO	AC MOTOR	70W MOTOR	3		6.1	132 cm	M 73-18m²	—	166 m³/min 5865 CFM		ABS			—	2300 lm	3000K 4000K 6000K	LED 24W			V2506423B	14-15
Bora		BCO	DC MOTOR	30W MOTOR	6		6.1	132 cm	M 73-18m²	IP44	185 m³/min 6533 CFM		ABS			—	2000 lm	3000K 4000K 6000K	LED 20W			V2516523B	16-17
Brisa		BCO	DC MOTOR	30W MOTOR	6		5.1	132 cm	M 73-18m²	—	189 m³/min 6677 CFM		ABS			—	1140 lm	3000K	LED 15W			V2503520B	18-19
		PLT	DC MOTOR	30W MOTOR	6		5.1	132 cm	M 73-18m²	—	189 m³/min 6677 CFM		ABS			—	1140 lm	3000K	LED 15W			V2503520PL	18-19
Garbin		NGR	DC MOTOR	30W MOTOR	6		7.2	132 cm	M 73-18m²	—	149 m³/min 5264 CFM		WOOD			—	—	—	—			V250252XNM	20-21
Raki		BCO	DC MOTOR	30W MOTOR	6		6.5	132 cm	M 73-18m²	—	155 m³/min 5476 CFM		PLYWOOD			—	—	—	—			V250452XB	22-23
		NGR	DC MOTOR	30W MOTOR	6		6.5	132 cm	M 73-18m²	—	155 m³/min 5476 CFM		PLYWOOD			—	—	—	—			V250452XN	24-25
		BCO	DC MOTOR	30W MOTOR	6		6.5	132 cm	M 73-18m²	—	155 m³/min 5476 CFM		GLASS PLYWOOD			3 Steps	1670 lm	3000K 4000K 6000K	LED 15W			V2504523B	26-27
Tramontana		BCO	DC MOTOR	30W MOTOR	6		5	132 cm	M 73-18m²	—	169 m³/min 5971 CFM		ABS			—	1640 lm	3000K	LED 18W			V2510540B	28-29

ARASHI



ARASHI



3000K



4000K



6000K

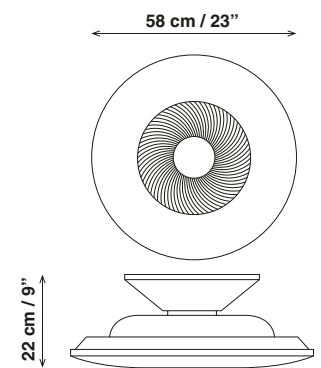

6	1	2	3	4	5	6
RPM	912	997	1082	1167	1252	1338
Decibelios	34,7dB	38,9B	42,7dB	46,3dB	49,3dB	51,1dB

SKU V2515593B

BCO DC MOTOR 18W MOTOR 6 3 Steps 3.8 KG 7-24M ABS 48 m³/min 1695 CFM 1900 lm 3000K 4500K 6000K LED 40W

BLAAST



BLAAST

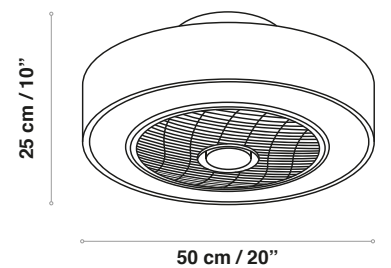

3000K



4500K



6000K

3	L	M	H
RPM	730	880	1070
Decibelios	18,2dB	26,04dB	36,35dB

SKU V2512503B

LEVANTE



LEVANTE

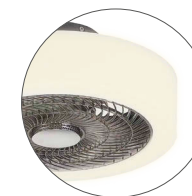
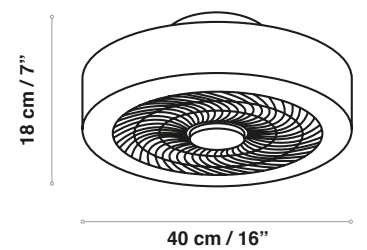

3000K

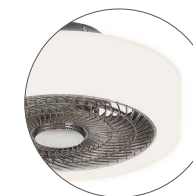

4000K



6000K

3	L	M	H
RPM	800	1000	1200
Decibelios	16,8dB	24,25dB	34,9dB

SKU V2511403FU

-
-
-
-
-
-
-
-
-
-
-
-
-
-
-
-



ZONDA

ZONDA



ASPAS RETRÁCTILES
Retractable blades
Pales rétractables
Einziehbare Schaufeln
Pale retrattili

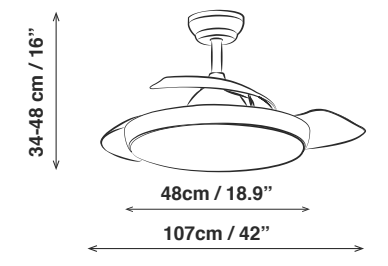

3	L	M	H
RPM	160	205	230
Decibelios	40dB	45dB	50dB

SKU V2514423B

BCO AC MOTOR 61W MOTOR 3 8.3 KG 3-18M ABS 102 m³/min 3600 CFM

4000 lm 3000K 4000K 6000K LED 47W 55 55 55



BARINE

BARINE

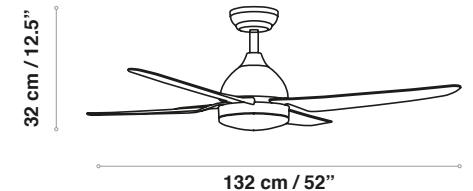

3000K



4000K



6000K

3	L	M	H
RPM	140	175	215
Decibelios	35dB	40dB	48dB

SKU V2506423B

BCO AC MOTOR 70W MOTOR 3 6.1 KG 13-18cm ABS 166 mm 5865 CFM 2300 lm 3000K 4000K 6000K LED 24W



BORA

BORA

💧 IP44 🌞

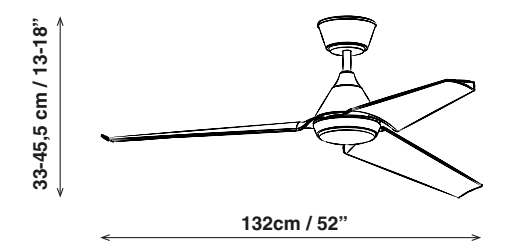

6	1	2	3	4	5	6
RPM	76	98	109	125	138	150
Decibelios	23dB	30dB	33dB	38dB	42dB	46dB

SKU V2516523B

-
-
-
-
-
-
-
-
-
-
-
-
-
-
-
-
-



BRISA

BRISA

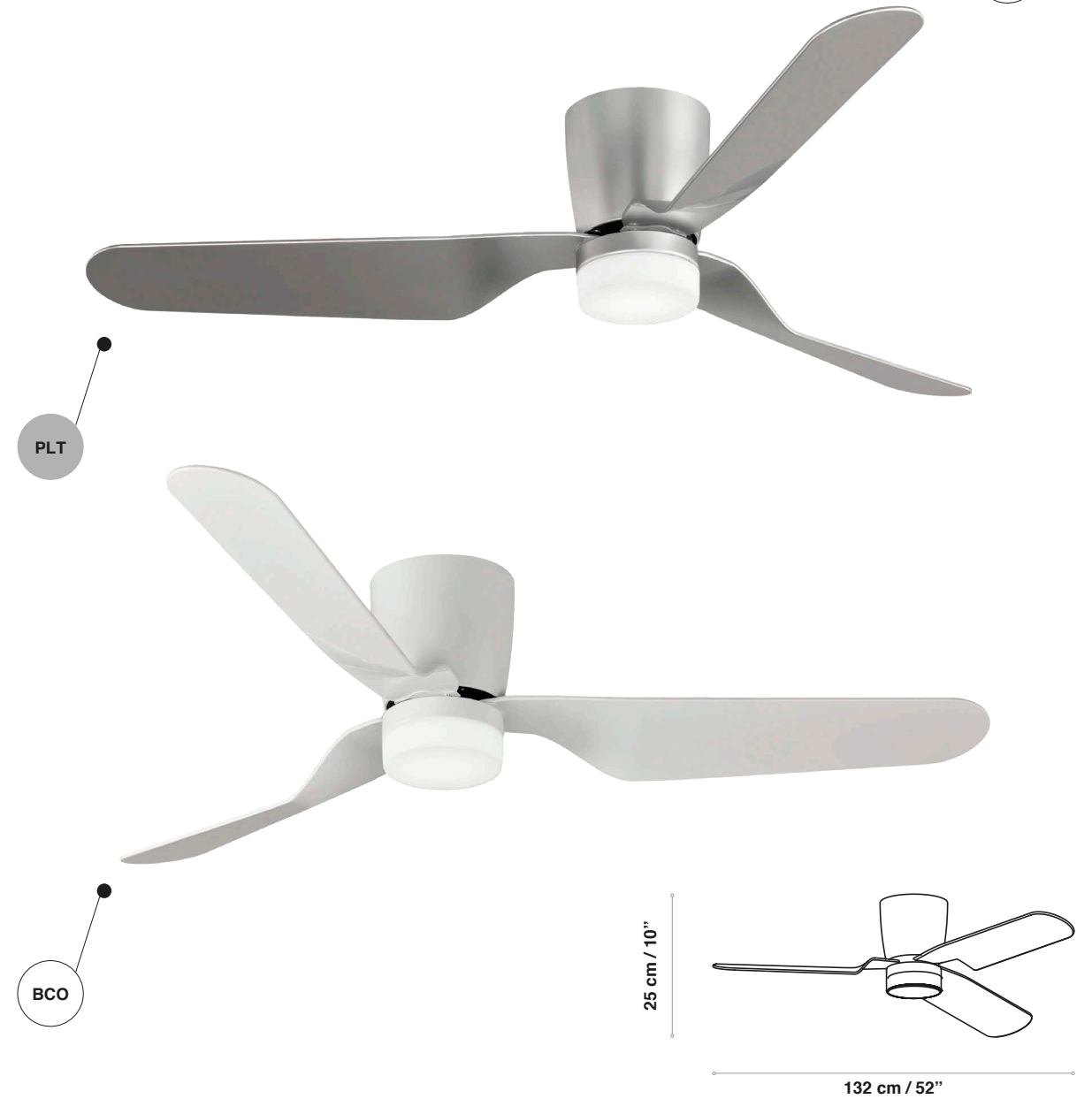

6	1	2	3	4	5	6
RPM	109	128	149	160	185	214
Decibelios	32,3dB	33dB	33,6dB	34dB	36,9dB	40,5dB

SKU V2503520B



SKU V2503520PL





GARBIN

GARBIN

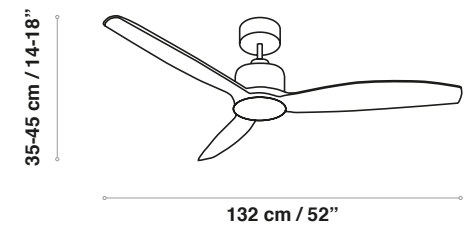

6	1	2	3	4	5	6
RPM	110	130	160	170	190	210
Decibelios	31,5dB	32dB	32,5dB	33,4dB	36,2dB	39,7dB

SKU V250252XNM



RAKI

RAKI



33-48 cm / 13-19"

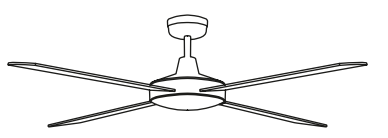

132 cm / 52"

6	1	2	3	4	5	6
RPM	68	100	127	147	160	178
Decibelios	33dB	33,5dB	34,2dB	34,7dB	37,14dB	42dB

SKU V250452XB

-
-
-
-
-
-
-
-
-
-
-
-
-
-
-
-



RAKI

RAKI

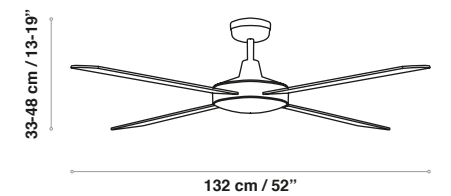

6	1	2	3	4	5	6
RPM	68	100	127	147	160	178
Decibelios	33dB	33,5dB	34,2dB	34,7dB	37,14dB	42dB

SKU V250452XN

-
-
-
-
-
-
-
-
-
-
-
-
-
-
-



RAKI

RAKI



3000K



4000K



6000K

33-48 cm / 13-19"

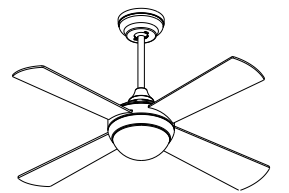

132 cm / 52"

6	1	2	3	4	5	6
RPM	68	100	127	147	160	178
Decibelios	33dB	33,5dB	34,2dB	34,7dB	37,14dB	42dB

SKU V2504523B

-
-
-
-
-
-
-
-
-
-
-
-
-
-
-
-
-
-
-

TRAMONTANA

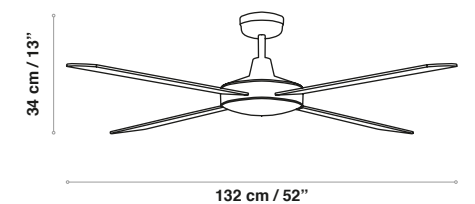

6	1	2	3	4	5	6
RPM	101	116	139	160	192	229
Decibelios	33,5dB	34dB	34,9dB	35,4dB	39,5dB	44,2dB

SKU V2510540B

-
-
-
-
-
-
-
-
-
-
-
-
-
-
-
-



TRAMONTANA

Simbología Symbology / Symbolologie / Symbolik / Simbologia

- PLT** **Plata**
Silver / Argent / Silber / Argento
- NGR** **Negro**
Black / Noir / Schwarz / Nero
- BCO** **Blanco**
White / Blanc / Weiß / Bianco
- OPAL FUMÉ** **Opal/Fumé**
Opal/Smoked / Opale/Fumé / Opal/Fumé / OpaleFumé
- AC MOTOR** **Motor AC**
AC Motor / Moteur AC / AC Motor / Motore AC
- DC MOTOR** **Motor DC**
DC Motor / Moteur DC / DC Motor / Motore DC
- 30W MOTOR** **Potencia del motor**
Engine power / Puissance du moteur / Motorleistung / Potenza del motore
- 3** **3 Velocidades**
3 Speeds / 3 Vitesses / 3 Geschwindigkeiten / 3 Velocità
- 6** **6 Velocidades**
6 Speeds / 6 Vitesses / 6 Geschwindigkeiten / 6 Velocità
- Función verano - invierno**
Summer - Winter function / Fonction été - hiver / Sommer - Winterfunktion / Funzione estate - inverno
- 5 KG** **Peso**
Weight / Le poids / Gewicht / Peso
- S 75m²** **Tamaño de la habitación: S**
Size of the room: S / Taille de la salle: S / Größe des Raumes: S / Dimensione della stanza: S
- M 13-18m²** **Tamaño de la habitación: M**
Size of the room: M / Taille de la salle: M / Größe des Raumes: M / Dimensione della stanza: M
- L 18m²** **Tamaño de la habitación: L**
Size of the room: L / Taille de la salle: L / Größe des Raumes: L / Dimensione della stanza: L
- 189 m³/min 5971 CFM** **Flujo de aire**
Airflow / Débit d'air / Luftstrom / Flusso d'aria
- 3** **3 Aspas**
3 Blades / 3 Pales / 3 Schaufeln / 3 Pale
- 4** **4 Aspas**
4 Blades / 4 Pales / 4 Schaufeln / 4 Pale
- 5** **5 Aspas**
5 Blades / 5 Pales / 5 Schaufeln / 5 Pale
- 3** **3 Aspas**
3 Blades / 3 Pales / 3 Schaufeln / 3 Pale
- 5** **5 Aspas**
5 Blades / 5 Pales / 5 Schaufeln / 5 Pale

- 7** **7 Aspas**
7 Blades / 7 Pales / 7 Schaufeln / 7 Pale
- ABS** **Material de las aspas: ABS**
Material of the blades: ABS / Matériau des pales: ABS / Material der Schaufeln: ABS / Materiale delle pale: ABS
- PC** **Material de las aspas: Policarbonato**
Material of the blades: Polycarbonate / Matériau des pales: Polycarbonate / Material der Schaufeln: Polycarbonat / Materiale delle pale: Policarbonato
- PLYWOOD** **Material de las aspas: Contrachapado**
Material of the blades: Plywood / Matériau des pales: Contre-plaqué / Material der Schaufeln: Sperrholz / Materiale delle pale: compensato
- WOOD** **Material de las aspas: Madera**
Material of the blades: Wood / Matériau des pales: Bois / Material der Schaufeln: Holz / Materiale delle pale: legno
- Aspas reversibles bicolor: negro mate y madera clara**
Reversible blades: matt black and pale wood / Pales interchangeable: noir mat et bois claire / Wendbare Klängen: mattschwarzes und helles Holz / Pale intercambiabili: nero opaco e legno chiaro
- Aspas reversibles bicolor: blanco mate y madera clara**
Reversible blades: matt white and pale wood / Pales interchangeable: blanc mat et bois claire / Wendbare Klängen: mattweißes und helles Holz / Pale intercambiabili: bianco opaco e legno chiaro
- Sin luz**
Without light / Sans lumière / Ohne Licht / Senza luce
- Con luz LED**
With LED light / Avec lumière LED / Mit LED-Licht / Con luce LED
- 1440 lm** **Lumens**
Lumens / Lumens / Lumens / Lumens
- 3000K** **Temperatura de color**
Colour temperature / Température de couleur / Farbtemperatur / Temperatura di colore
- 3000K 4000K 5000K** **Temperatura de color regulable**
Adjustable Colour temperature / Température de couleur réglable / Einstellbare Farbtemperatur / Temperatura di colore regolabile
- LED 18W** **Potencia de la luz**
Power of light / Puissance de la lumière / Lichtleistung / Potenza della luce
- 3 Steps** **Dimable**
Dimmable / Dimmable / Dimmbar / Dimmerabile
- Mando incluido**
Remote control included / Télécommande inclus / Fernbedienung enthalten / Telecomando inclusi
- Temporizador**
Timer / Minuterie / Timer / Timer
- Adecuado para techos inclinados**
Suitable for sloping roof / Convient aux toits en pente / Geeignet für Dachschrägen / Adatto a tetto inclinato
- 2** **2 Tamaños diferentes de tijas**
2 Size of rods / 2 Taille de tiges / 2 Stabgröße / 2 dimensioni delle aste
- IP44** *IP44*

Grado de protección / Degree of protection / Niveau de protection / Grado di protezione / Schutzart

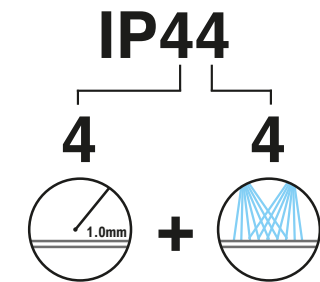
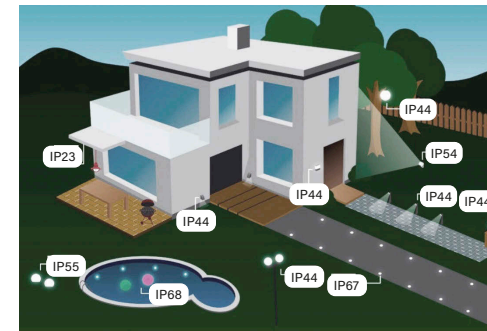

Índice de protección contra la penetración de partículas sólidas y húmedas / Protection degree offered by the fixture to the ingress of solids and liquids / Indice de protection contre la pénétration des corps solides et des liquides / Indice di protezione contro la penetrazione di corpi solidi e di liquidi / Schutzgrad gegen feste Fremdkörper und Wasser

	1a cifra, protección contra la penetración de cuerpos sólidos	<i>1st figure, protection against penetration by solid bodies</i>	<i>1er chiffre, protection contre la pénétration de corps solide</i>	<i>1a cifra, protezione contro la penetrazione dei corpi solidi</i>	<i>1. Kennziffer: Schutz gegen Eindringen fester Körper</i>
0	Ninguna protección	<i>No protection</i>	<i>Sans protection</i>	<i>Nessuna protezione</i>	<i>Ungeschützt</i>
1	Protección contra cuerpos sólidos de tamaño superior a 50mm	<i>Protected against solid bodies over 50 mm in diameter</i>	<i>Protection contre les corps solides de dimensions supérieures à 50 mm</i>	<i>Protezione contro i corpi solidi di dimensioni superiori a 50mm</i>	<i>Fremdkörper grösser als 50 mm</i>
2	Protección contra cuerpos sólidos de tamaño superior a 12mm	<i>Protected against solid bodies over 12 mm in diameter</i>	<i>Protection contre les corps solides de dimensions supérieures à 12 mm</i>	<i>Protezione contro i corpi solidi di dimensioni superiori a 12mm</i>	<i>Geschützt gegen feste Fremdkörper grösser als 12 mm</i>
3	Protección contra cuerpos sólidos de tamaño superior a 2,5mm	<i>Protected against solid bodies over 2,5 mm in diameter</i>	<i>Protection contre les corps solides de dimensions supérieures à 2,5 mm</i>	<i>Protezione contro i corpi solidi di dimensioni superiori a 2,5mm</i>	<i>Geschützt gegen feste Fremdkörper grösser als 2,5 mm</i>
4	Protección contra cuerpos sólidos de tamaño superior a 1mm	<i>Protected against solid bodies over 1 mm in diameter</i>	<i>Protection contre les corps solides de dimensions supérieures à 1 mm</i>	<i>Protezione contro i corpi solidi di dimensioni superiori a 1mm</i>	<i>Geschützt gegen feste Fremdkörper grösser als 1 mm.</i>
5	Protección contra el polvo	<i>Protected against dust</i>	<i>Protection contre les poussières</i>	<i>Protezione contro la polvere</i>	<i>Staubgeschützt.</i>
6	Totalmente protegido contra el polvo	<i>Fully protected against dust.</i>	<i>Totalement protégé contre les poussières</i>	<i>Totalmente protetto contro la polvere.</i>	<i>Staubgeschützt.</i>
	2a cifra, protección contra la penetración de agua	<i>2nd figure, protection against water infiltration</i>	<i>2ème chiffre, protection contre l'infiltration d'eau</i>	<i>2a cifra, protezione contro l'infiltrazione di acqua</i>	<i>2. Kennziffer: Schutz gegen Wassereintritt</i>
0	Ninguna protección	<i>No protection</i>	<i>Sans protection</i>	<i>Nessuna protezione</i>	<i>Ungeschützt</i>
1	Protección contra caída vertical de gotas de agua	<i>Protected against drops of water falling vertically</i>	<i>Protection contre les chutes verticales de gouttes d'eau.</i>	<i>Protezione contro la caduta in verticale di gocce d'acqua</i>	<i>Geschützt gegen senkrecht fallendes Tropfwasser.</i>
2	Protección contra caída vertical de gotas de agua, 15° máx. inclinación	<i>Protected against drops of water at a max.inclination of 15 degrees</i>	<i>Protection contre les chutes verticales de gouttes d'eau avec angle d'inclinaison max. de 15°</i>	<i>Protezione contro la caduta in verticale di gocce d'acqua con angolo di inclinazione max di 15°</i>	<i>Geschützt gegen schräg fallendes Tropfwasser mit einem Winkel bis zu 15°</i>
3	Protección contra caída vertical de gotas de agua, 60° máx. inclinación	<i>Protected against drops of water at a max. inclination of 60 degrees</i>	<i>Protection contre les chutes verticales de gouttes d'eau avec angle d'inclinaison max. de 60°</i>	<i>Protezione contro la caduta in verticale di gocce d'acqua con angolo di inclinazione max di 60°</i>	<i>Geschützt gegen schräg fallendes Tropfwasser mit einem Winkel bis zu 60°</i>
4	Protección contra salpicaduras de agua.	<i>Protected against splashed of water</i>	<i>Protection contre les éclaboussures d'eau.</i>	<i>Protezione contro gli spruzzi d'acqua</i>	<i>Geschützt gegen Spritzwasser.</i>
5	Protección contra chorros de agua.	<i>Protected against jets of water</i>	<i>Protection contre les projections d'eau.</i>	<i>Protezione contro i getti d'acqua</i>	<i>Geschützt gegen Strahlwasser.</i>
6	Protección contra olas de agua	<i>Protected against waves</i>	<i>Protection contre les vagues d'eau.</i>	<i>Protezione contro le ondate d'acqua</i>	<i>Geschützt gegen Seewellen</i>
7	Protección contra inmersión	<i>Immersion protected</i>	<i>Protection contre l'immersion</i>	<i>Protezione contro l'immersione</i>	<i>Eintauchgeschützt</i>
8	Protección contra inmersión prolongada	<i>Protected against long term immersion</i>	<i>Protection contre l'immersion prolongée.</i>	<i>Protezione contro l'immersione prolungata.</i>	<i>Geschützt gegen dauerhaftes Eintauchen</i>

ACB | *Vento!*

Toda la información en este catálogo sirve simplemente como una indicación y no es vinculante para la empresa. La empresa se reserva el derecho de modificar o variar los productos para mejoras técnicas o estéticas sin previo aviso. Las marcas y los logotipos pertenecen a sus legítimos propietarios.

All information in this catalogue merely serves as an indication and it is not binding for the company. The company reserves the right to modify any contents or information, even without prior notice. Brand names and logos belong to their legitimate owners.

Toutes les informations contenues dans ces catalogues ont une valeur indicative, et ne s'entendent pas contraignantes pour l'entreprise. La société se réserve le droit de modifier tout contenu ou information, en y apportant des améliorations techniques et visuelles, y compris sans communication préalable. Les marques et logos sont propriété de leurs dépositaires légitimes.

Alle Angaben in diesem Katalog dienen lediglich als Hinweis und sind für das Unternehmen nicht verbindlich. Das Unternehmen behält sich das Recht vor, Inhalte oder Informationen auch ohne vorherige Ankündigung zu ändern, um technische oder ästhetische Verbesserungen zu erreichen. Markennamen und Logos gehören ihren rechtmäßigen Eigentümern.

Tutte le informazioni presenti in questo catalogo sono soltanto indicative e non sono vincolanti per l'azienda. La società si riserva il diritto di modificare o effettuare variazioni sui prodotti per miglioramenti tecnici o estetici senza preavviso. I marchi e i loghi appartengono ai legittimi proprietari.

Los diseños que contiene este catálogo de la empresa española con CIF B96498233, están registrados y protegidos por la Ley de Protección de Diseño Industrial.

All designs included in this catalogue from the Spanish Company with CIF B96498233, being registered and protected by the Industrial Design Protection Law.

© Copyright. 2021 CIF B96498233

NACIONAL:

Telf. +34 962 779 021

comercial@acbiluminacion.com

EXPORT:

Telf. +34 962 779 166

export@acbiluminacion.com

EXPORT ITALIA:

Telf. +39 02 82940900

acb.italia@acbiluminacion.com

EXPORT FRANCE :

Telf. +34 962 779 166

france1@acbiluminacion.com



Camino de Valencia 104, CP, 46190
Ribarroja del Turia (Valencia) Spain
www.acbiluminacion.com